

V1-C

RF DIM

LED Dimmer

- 1 channel constant voltage LED RF dimmer with 3-button.
- Switch and dimming by 3 buttons.
- Match with RF 2.4G single zone or multiple zone dimming remote control optional.
- One RF controller accept up to 10 remote control.
- 4096 levels 0-100% dimming smoothly without any flash.
- PWM frequency 500Hz, 2KHz, 8KHz or 16KHz selectable.
- Connect with external push switch to achieve on/off and 0-100% dimming function.
- Over-heat / Over-load / Short circuit protection, recover automatically.



CE RoHS LVD RED

3-button / Step-less dimming/ RF dimming / Four PWM frequency / Push Dim/Multiple protection

Technical Parameters

Input and Output		Dimming data		Safety and EMC	
Input voltage	12-24VDC	Input signal	3-button + RF 2.4GHz+Push Dim	EMC standard (EMC)	ETSI EN 301 489-1 V2.2.3
Input current	20.5A	Control distance	30m(Barrier-free space)	EMC standard (EMC)	ETSI EN 301 489-17 V3.2.4
Output voltage	12-24VDC	Dimming gray scale	4096 (2 ¹²) levels	Safety standard	EN 62368-1:2020+A11:2020
Output current	20A@500Hz/2KHz 15A@8KHz 12A@16KHz	Dimming range	0-100%	Radio Equipment(RED)	ETSI EN 300 328 V2.2.2
Output power	240-480W@500Hz/2KHz 180-360W@8KHz 144-288W@16KHz	Dimming curve	Logarithmic	Certification	CE,EMC,RED
Environment		PWM frequency	500Hz/2KHz/8KHz/16KHz	Package	
Operation temperature	Ta: -30°C ~ +55°C	Warranty and Protection		Size	L100 x W46 x H38mm
Case temperature (Max.)	Tc: +85°C	Warranty	5 years	Gross weight	0.081kg
		Protection	Reverse polarity Over-heat Over-load Short circuit		

Mechanical Structures and Installations

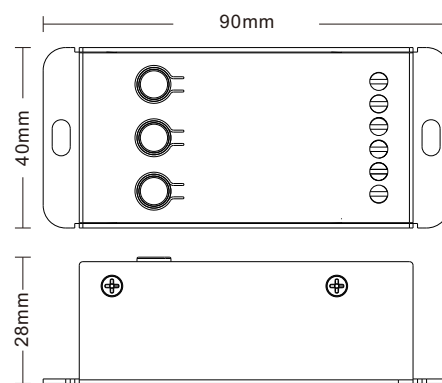
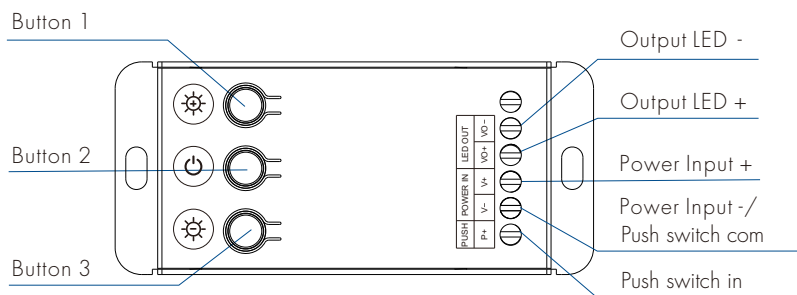

Wiring Diagram

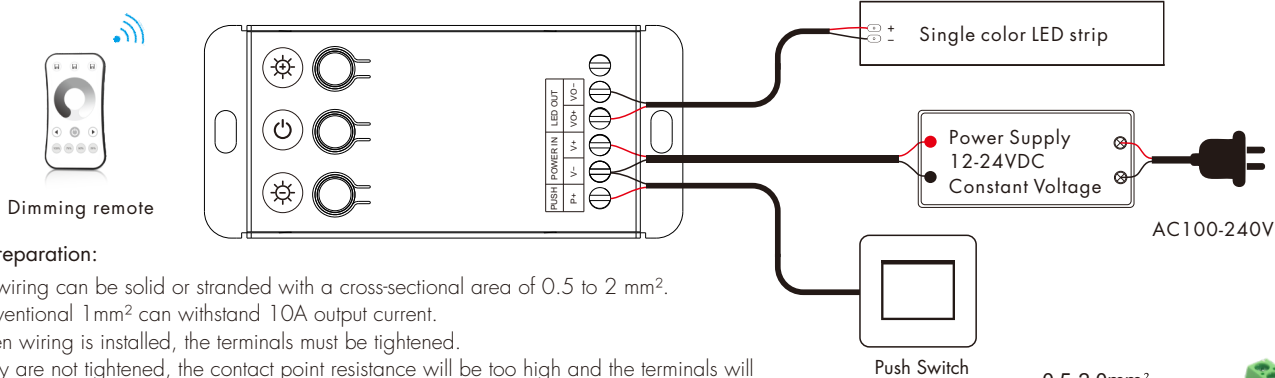



Wire Preparation:

1. The wiring can be solid or stranded with a cross-sectional area of 0.5 to 2 mm². Conventional 1mm² can withstand 10A output current.
2. When wiring is installed, the terminals must be tightened. If they are not tightened, the contact point resistance will be too high and the terminals will easily burn due to heat when used at full load for a long time.

Note: The output power of a constant voltage power supply should be at least 1.2 times that of the output load (light strip), otherwise the full power output of the load can easily cause automatic flickering or shaking of the light.

Button function

-  Increase brightness, short press 10 levels, long press 1-6s for continuous 256 levels adjustment.
-  Turn on or off light.
-  Decrease brightness, short press 10 levels, long press 1-6s for continuous 256 levels adjustment.

Push Dim Function

The provided Push-Dim interface allows for a simple dimming method using commercially available non-latching (momentary) wall switches.

- **Click:** Turn on or off light.
- **Double-click:** Switch between 10% or 100% light brightness.
- **Long press(1-6s):** Press and hold to step-less dimming, With every other long press, the light level goes to the opposite direction.
- **Dimming memory:** Light returns to the previous dimming level when switched off and on again, even at power failure.
- **Synchronization:** If more than one controller are connected to the same push switch, do a long press for more than 10s, then the system is synchronized and all lights in the group dim up to 100%.

This means there is no need for any additional synchrony wire in larger installations.

We recommend the number of controllers connected to a push switch does not exceed 25 pieces,

The maximum length of the wires from push to controller should be no more than 20 meters.

PWM frequency setting

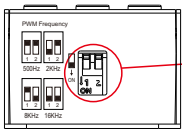

We can select four PWM frequency: 500Hz, 2KHz, 8KHz or 16KHz.

Higher PWM frequency, will cause lower output current, higher power noise, but more suitable for camera(No flickers for video).

Match Remote Control (two match ways)

End user can choose the suitable match/delete ways. Two options are offered for selection:

Use the controller's button

Match:

Long press button 1 and button 3 for 2s, the output LED blinks 2 times, immediately press on/off key (single zone remote) or zone key (multiple zone remote) of the remote.

The output LED blinks 3 times means match is successful.

Delete:

Press and hold button 1 and button 3 for 5s to delete all match, The output LED blinks 5 times means all matched remotes were deleted.

Use Power Restart

Match:

Switch off the power, then switch on power again, repeat again, immediately short press on/off key (single zone remote) or zone key (multiple zone remote) 3 times on the remote.

The output LED blinks 3 times means match is successful.

Delete:

Switch off the power, then switch on power again, repeat again, immediately short press on/off key (single zone remote) or zone key (multiple zone remote) 5 times on the remote.

The output LED blinks 5 times means all matched remotes were deleted.

Dimming Curve

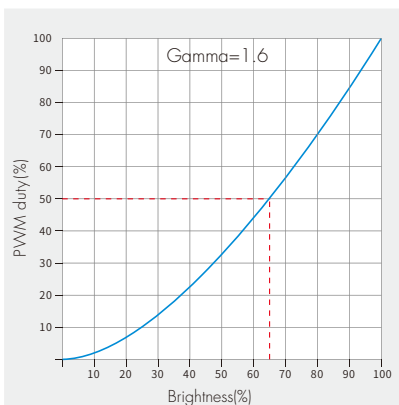

Installation Precautions

1. The products shall not be stacked, the distance should be ≥ 20 cm, so as not to affect lifespan of the products due to poor heat dissipation.
2. The product shall not be installed close to the switching power supply with an interval of ≥ 20 cm to avoid radiation interference of the switching power supply.
3. The installation height shall be ≥ 1 m from the floor to avoid shortening the remote control distance due to too weak reception signal.
4. The products are not allowed to be close to or covered by metal objects, with an interval of ≥ 20 cm to avoid signal attenuation and shorten the remote distance.
5. Avoid installation at the corner of the wall or the corner of the beam, with an interval of ≥ 20 cm to avoid signal interference.